

Dimensional drawing **2SP7867, 2SP7877**

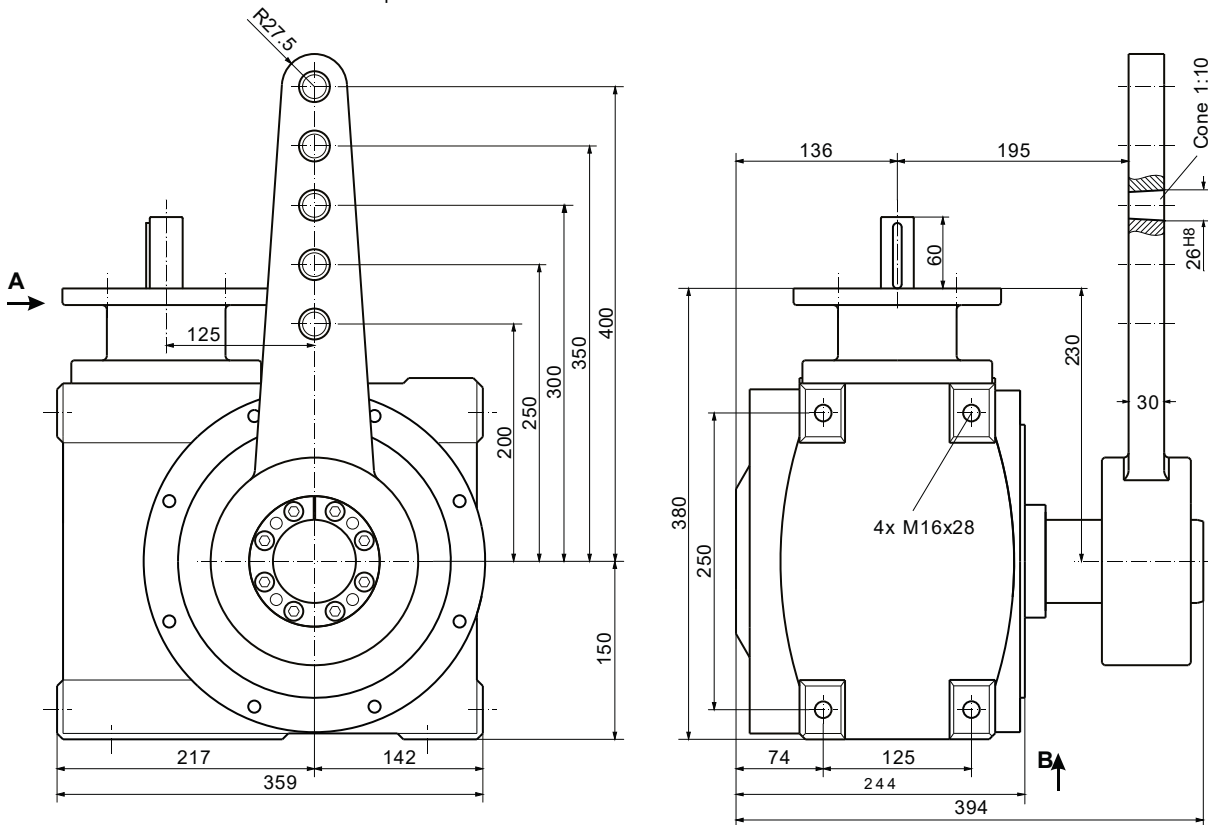

2SA7843-9 -5  
2SA7853-9 -5

Flange F14  
Output shaft B3



Details A

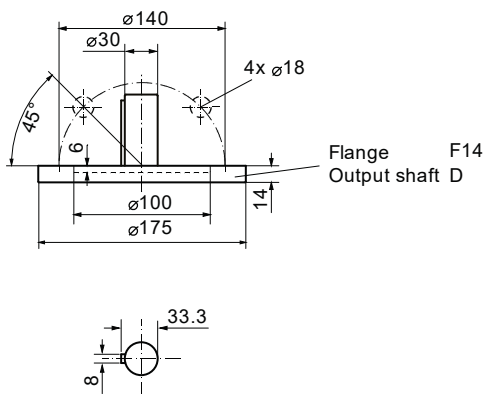

Details B

